

206037-1  ACTIVE

AMP | AMP CPC

TE Internal #: 206037-1

Circular Power Connectors, Housing, 600 VDC, Wire-to-Wire, 16 Position, Wire & Cable, Plug, Socket, Power & Signal, Black, All Plastic, AMP CPC

[View on TE.com >](#)



Connectors > Power Connectors > Circular Power > Circular Power Connectors > Circular Connector, Environmentally Sealed, CPC Series 6



Connector Product Type: **Housing**

Operating Voltage: **600 VDC**

Connector System: **Wire-to-Wire**

Number of Positions: **16**

Sealable: **No**

[All Circular Connector, Environmentally Sealed, CPC Series 6 \(19\)](#)

## Features

### Product Type Features

Connector Product Type	Housing
Connector System	Wire-to-Wire
Sealable	No
Connector & Contact Terminates To	Wire & Cable
Connector & Housing Type	Plug
Circular Connector Shell Type	All Plastic

### Configuration Features

Reverse Numbering	Without
Number of Positions	16
Number of Power Positions	0
Number of Signal Positions	16

### Electrical Characteristics



Operating Voltage	600 VAC
-------------------	---------

### Contact Features

Reverse Gender	No
----------------	----

Contact Type	Socket
--------------	--------

Contact Protection	With
--------------------	------

### Mechanical Attachment

Mating Alignment Type	Keyed
-----------------------	-------

Mating Alignment	With
------------------	------

Mating Retention Type	Threaded Coupling
-----------------------	-------------------

Screw & Hole Thread Size	15/16-20 UNEF – 2A
--------------------------	--------------------

Polarization Code	A
-------------------	---

Connector Mounting Type	Cable Mount (Free-Hanging)
-------------------------	----------------------------

Mating Retention	With
------------------	------

Panel Mount Feature	Without
---------------------	---------

### Housing Features

Body Orientation	Straight
------------------	----------

Housing Color	Black
---------------	-------

Housing Material	Nylon - GF
------------------	------------

Circular Connector Shell Size	17
-------------------------------	----

### Usage Conditions

Operating Temperature Range	-55 – 105 °C[-67 – 221 °F]
-----------------------------	----------------------------

Fluid Resistance	None
------------------	------

### Operation/Application

Circuit Application	Power & Signal
---------------------	----------------

Shielded	No
----------	----

### Industry Standards

UL Flammability Rating	UL 94V-0
------------------------	----------

### Packaging Features

Packaging Quantity	100
--------------------	-----

Packaging Method	Bag
------------------	-----

### Product Compliance



[For compliance documentation, visit the product page on TE.com>](#)

EU RoHS Directive 2011/65/EU	Compliant
EU ELV Directive 2000/53/EC	Compliant
China RoHS 2 Directive MIIT Order No 32, 2016	No Restricted Materials Above Threshold
EU REACH Regulation (EC) No. 1907/2006	Current ECHA Candidate List: JAN 2023 (233) Candidate List Declared Against: JAN 2023 (233) Does not contain REACH SVHC
Halogen Content	Not Low Halogen - contains Br or Cl > 900 ppm.
Solder Process Capability	Not applicable for solder process capability

Product Compliance Disclaimer

This information is provided based on reasonable inquiry of our suppliers and represents our current actual knowledge based on the information they provided. This information is subject to change. The part numbers that TE has identified as EU RoHS compliant have a maximum concentration of 0.1% by weight in homogenous materials for lead, hexavalent chromium, mercury, PBB, PBDE, DBP, BBP, DEHP, DIBP, and 0.01% for cadmium, or qualify for an exemption to these limits as defined in the Annexes of Directive 2011/65/EU (RoHS2). Finished electrical and electronic equipment products will be CE marked as required by Directive 2011/65/EU. Components may not be CE marked. Additionally, the part numbers that TE has identified as EU ELV compliant have a maximum concentration of 0.1% by weight in homogenous materials for lead, hexavalent chromium, and mercury, and 0.01% for cadmium, or qualify for an exemption to these limits as defined in the Annexes of Directive 2000/53/EC (ELV). Regarding the REACH Regulation, the information TE provides on SVHC in articles for this part number is based on the latest European Chemicals Agency (ECHA) 'Guidance on requirements for substances in articles' posted at this URL: <https://echa.europa.eu/guidance-documents/guidance-on-reach>

## Compatible Parts

 <p>TE Part # CAT-AM71-C83998J Cable/Panel Mount Connector, CPC Series 1</p>	 <p>TE Part # CAT-AM71-A17 POWERBAND Contacts</p>	 <p>TE Part # CAT-AM71-C83998AA Two-Piece Receptacle, CPC Series 6</p>	 <p>TE Part # CAT-AM71-C83998U Environmentally Sealed Circular Connector, CPC Series 5</p>
 <p>TE Part # CAT-AM71-C83998BB CPC SERIES 3</p>	 <p>TE Part # 207299-3 FLANGE PLUG MOUNT CPC</p>	 <p>TE Part # CAT-AM71-C83998 CPC Heat Shrink Strain Reliefs</p>	 <p>TE Part # CAT-AM71-C83998W Sealed Accessories for CPC Series 5</p>



TE Part # CAT-AM71-C83998F  
Connectors with Posted Pin Contacts,  
CPC Series 1



TE Part # 81665-2  
FLANGE GASKET CPC



TE Part # 206044-1  
CPC PLUG ASSEMBLY SIZE 17-14



TE Part # 207292-2  
CPC RECPT ASY FEED THRU 17-16



TE Part # 213810-1  
CPC COUPLING RING SIZE 17



TE Part # 206036-3  
RECEPT,SZ 17-16,CPC



TE Part # 213933-1  
CPC,STRAIN RELIEF,SIZE 17



TE Part # 206036-1  
RECEPT,SZ 17-16 CPC



TE Part # 206404-2  
CPC RECPT ASSEMBLY SIZE 17-16



TE Part # 213899-1  
CPC SEAL ASSY KIT,SRS 5,17-3



TE Part # 213900-1  
CPC SEAL ASSY KIT,SRS 6,17-10

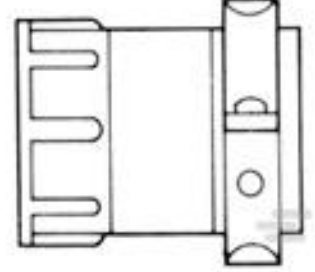

TE Part # 1-206322-1  
CABLE CLAMP KIT, BULK PKG

## Also in the Series | AMP CPC



Circular Connector Adapters(7)



Circular Connector Boots & Strain Relief(6)



Circular Connector Caps & Covers(16)



Circular Connector Hardware(3)



Circular Connector Keying Plugs(2)



Circular Connector Seals(36)



Circular Power Connectors(460)



Insertion & Extraction Tools(1)

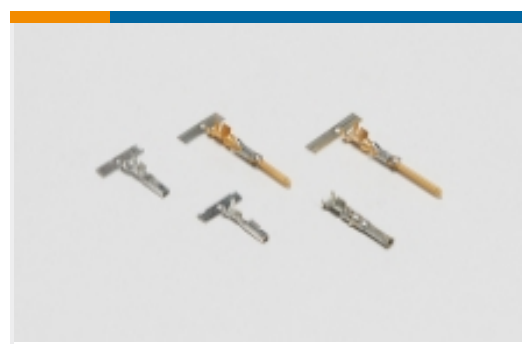

Power Contacts(6)

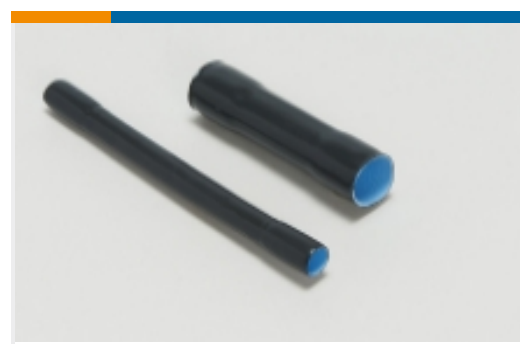

Sealing Sleeves(2)

Unscreened Circular Connector  
Backshells & Clamps(56)

## Customers Also Bought

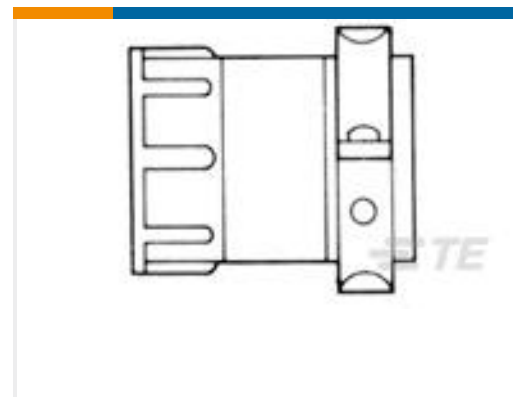
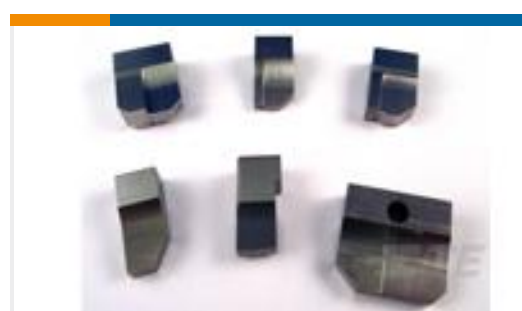
TE Part #206151-1  
Cable/Panel Mount Connector, CPC  
Series 1TE Part #206305-1  
Circular Connector, Environmentally  
Sealed, CPC Series 6TE Part #206322-9  
CABLE CLAMP SIZE 17TE Part #1-206070-1  
CABLE CLAMP KIT #17TE Part #1463047-8  
ANVIL, SUPER SEAL 3-1447221-3

## Documents

### Product Drawings

CPC PLUG ASSEMBLY SIZE 17-16

English

### CAD Files

3D PDF

3D

Customer View Model

[ENG\\_CVM\\_CVM\\_206037-1\\_S.2d\\_dxf.zip](#)

English

Customer View Model

[ENG\\_CVM\\_CVM\\_206037-1\\_S.3d\\_igs.zip](#)

English

Customer View Model

[ENG\\_CVM\\_CVM\\_206037-1\\_S.3d\\_stp.zip](#)

English

By downloading the CAD file I accept and agree to the [Terms and Conditions](#) of use.



---

### Datasheets & Catalog Pages

[AMP Circular Connectors for Commercial Signal & Power Applications](#)

English

---

### Product Specifications

[Application Specification](#)

English

---

### Product Environmental Compliance

[MD\\_206037-1\\_110220171414\\_dmtec](#)

English

[MD\\_206037-1\\_110220171414\\_dmtec](#)

English

---

### Instruction Sheets

[Instruction Sheet \(U.S.\)](#)

English

[Instruction Sheet \(U.S.\)](#)

English

---

### Agency Approvals

[UL Report](#)

English